

System drawing

Wall junction

System design – Detail

Detail waterproofing:

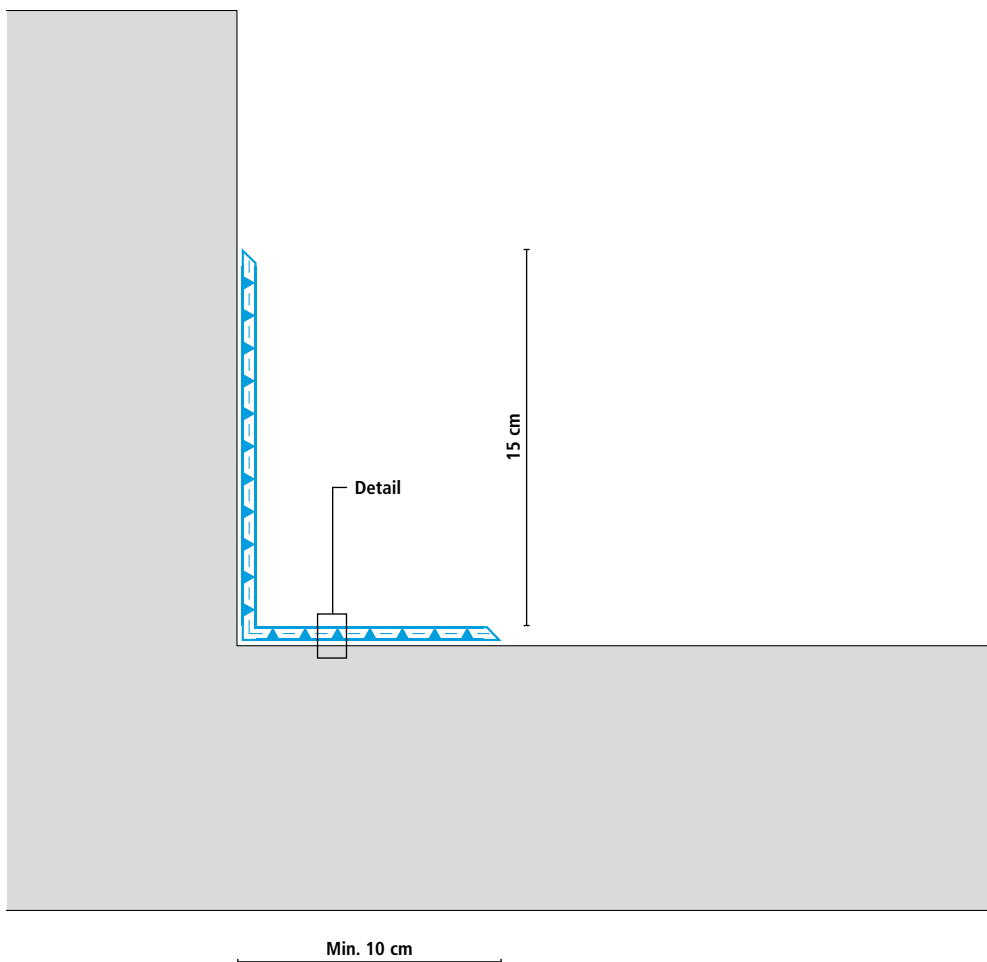
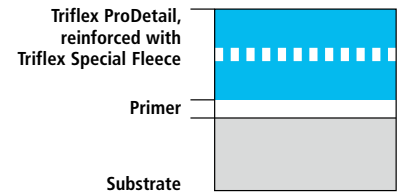

System drawing

Gully

System design – Detail

Detail waterproofing:

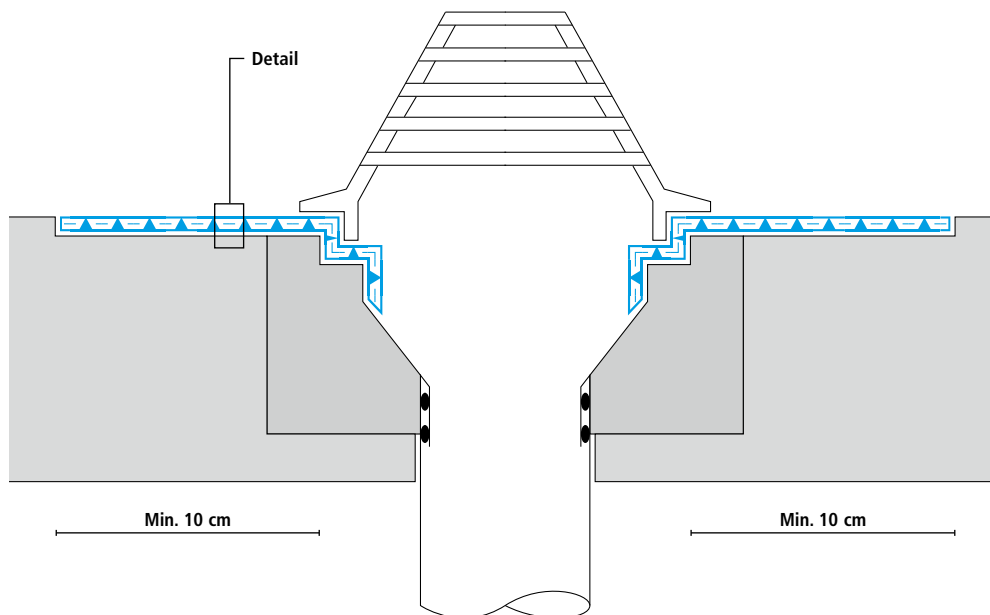
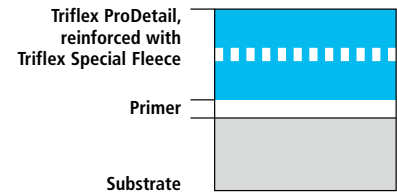

System drawing

Penetration

System design – Detail

Detail waterproofing:

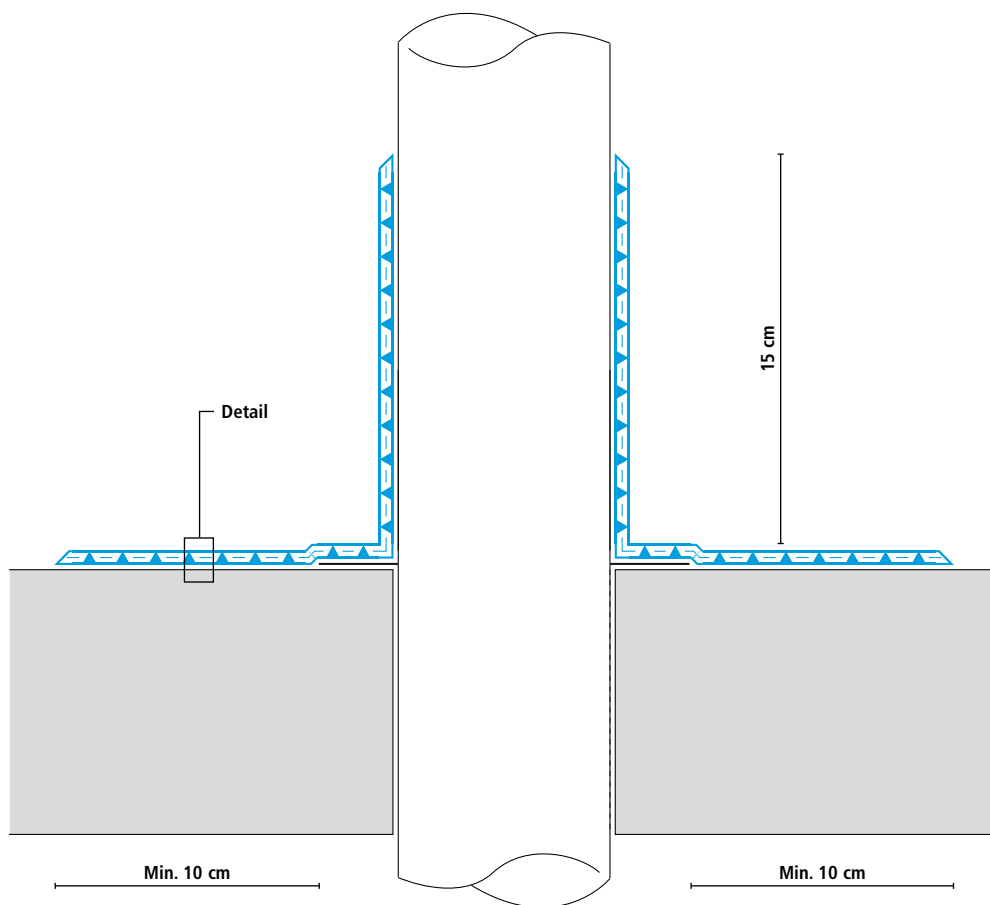
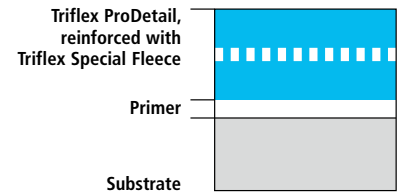

System drawing

Edge finishing with bracket-mounted gutter

System design – Detail

Detail waterproofing:

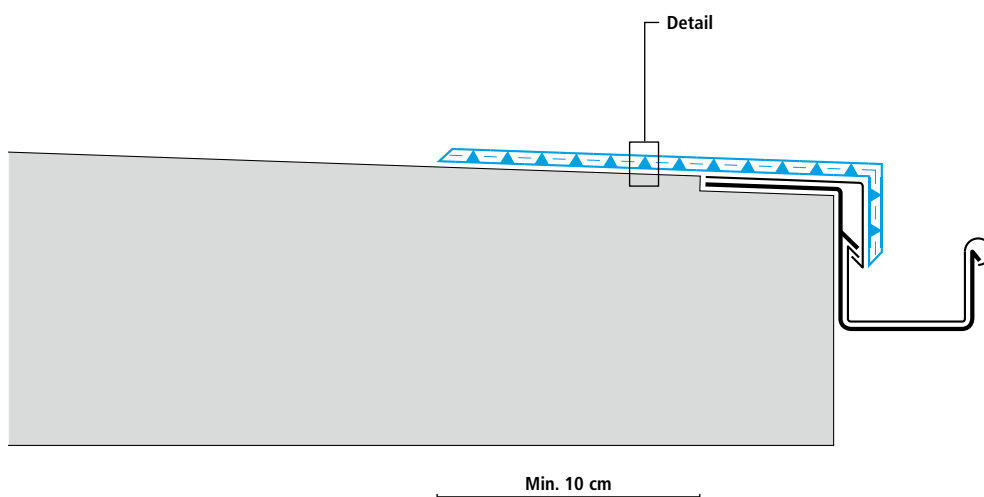
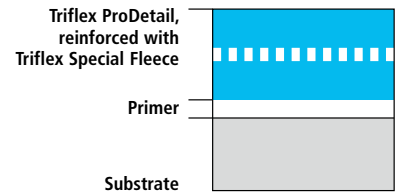

System drawing

Parapet edge finishing

System design – Detail

Detail waterproofing:

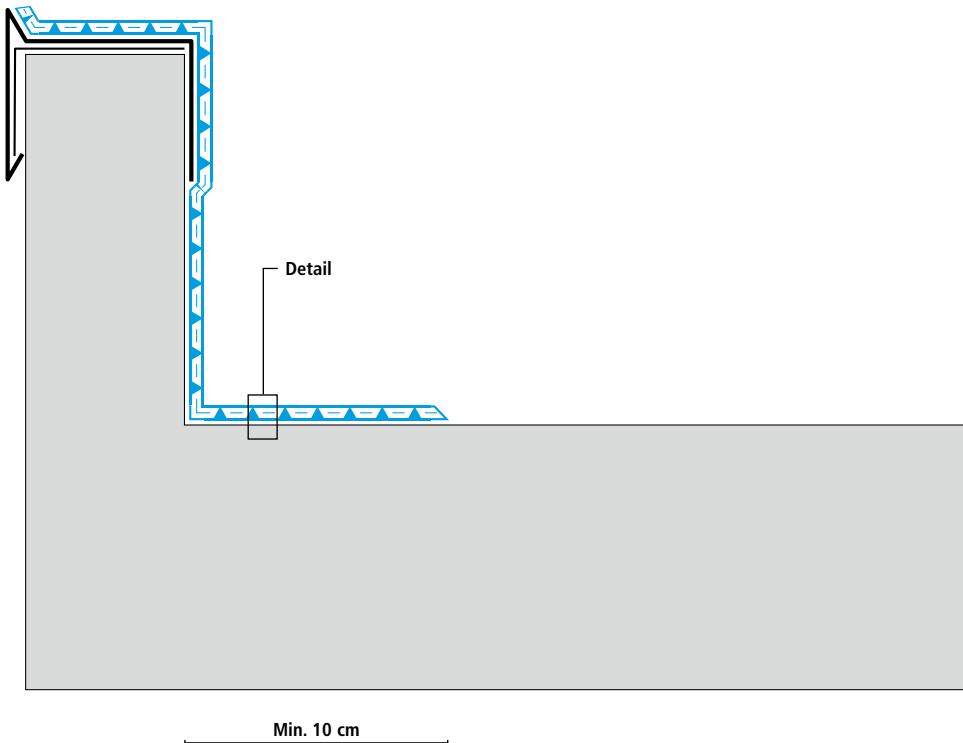
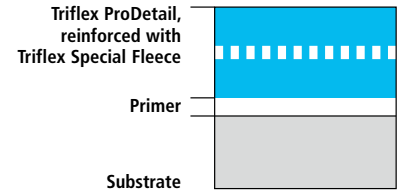

System drawing

Light dome

System design – Detail

Detail waterproofing:

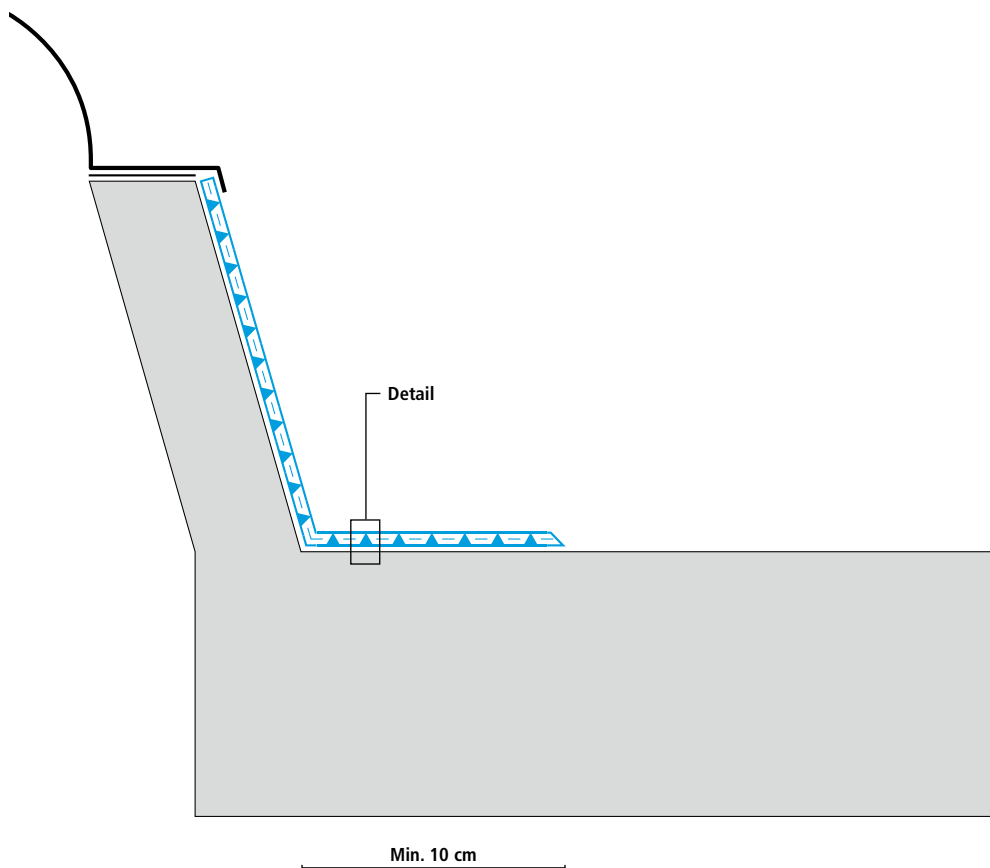
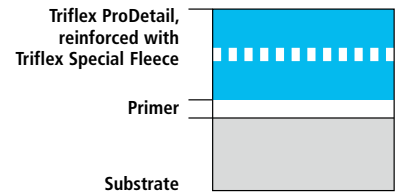

System drawing

Settlement joint

System design – Detail

Detail waterproofing:

